

**MODU
SPACE**

Bespoke Showcase Engineers

MAX140 Assembly Guide

Version 3.0

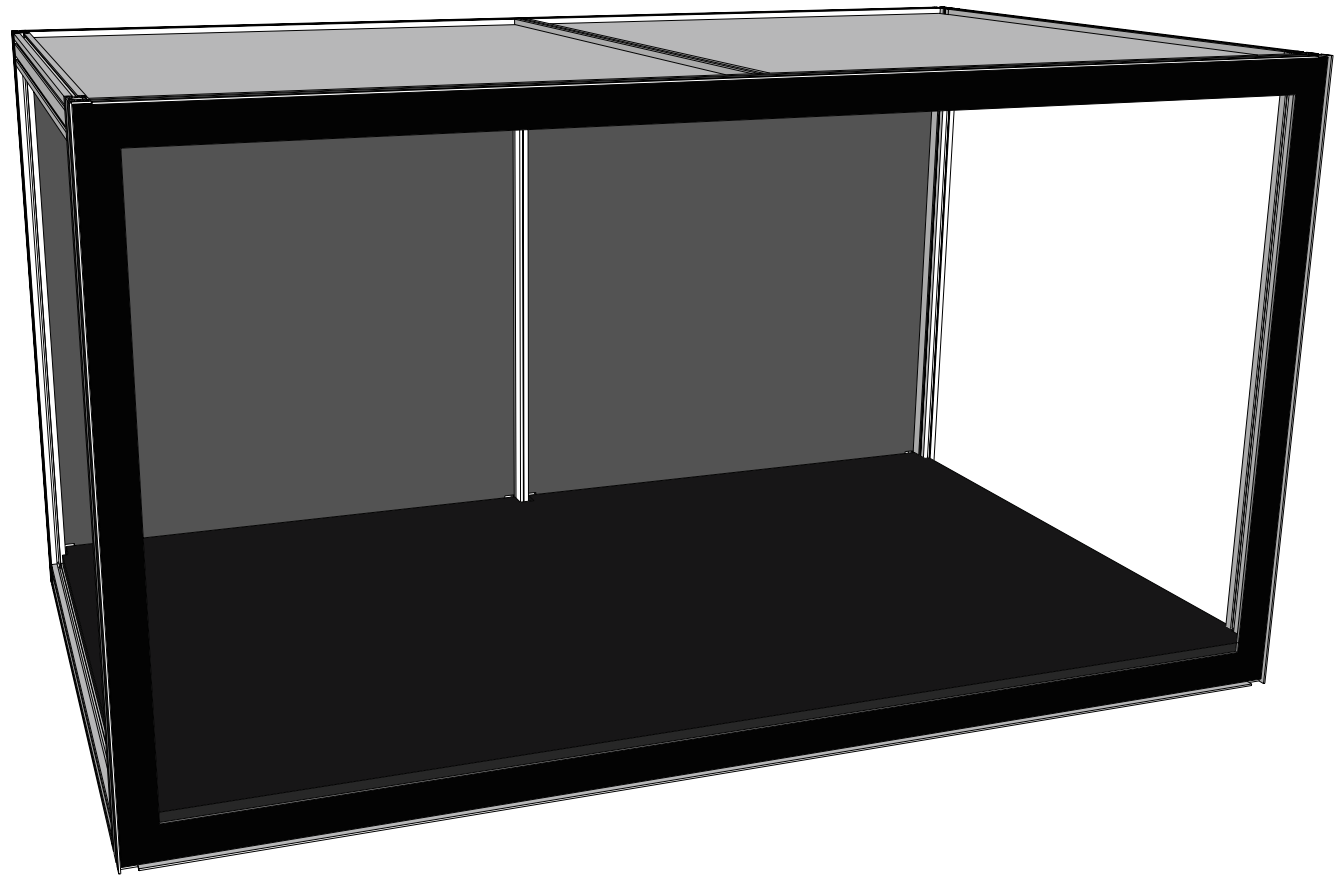

Back Frame
Middle Vertical Bar



Back Frame
Vertical Bar x 2

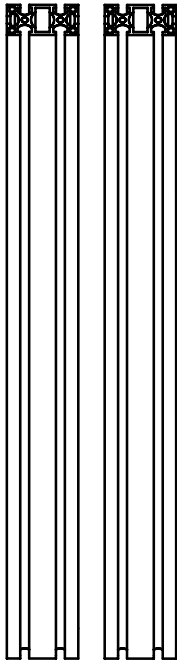

Back Frame
Horizontal Bar x 2

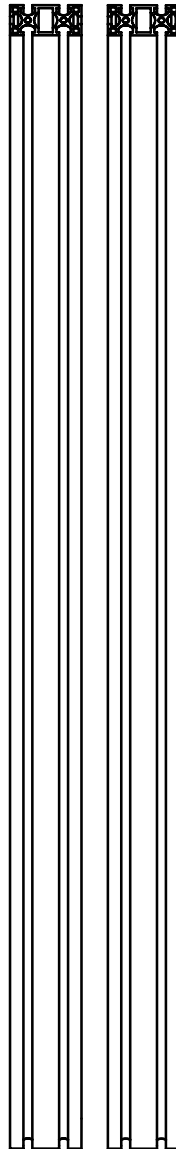

Front Frame
Horizontal Bar x2

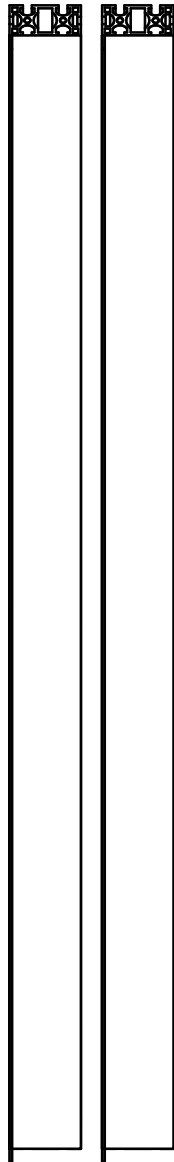

Front Frame
Vertical Bar x 2

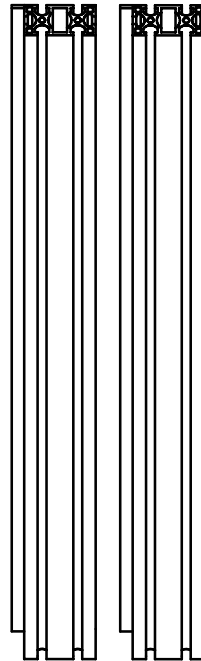

Side Frame
Horizontal Bar x 4

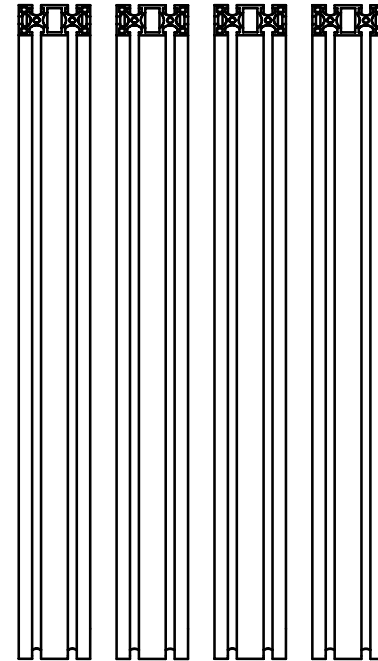

Middle Top
Horizontal Bar x1

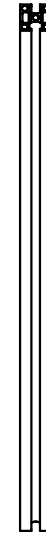

Middle Bottom
Horizontal Bars x 2



Conduits x 2



Vertical C-Channel x 4

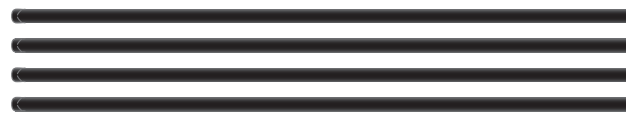

Horizontal C-Channel x 4



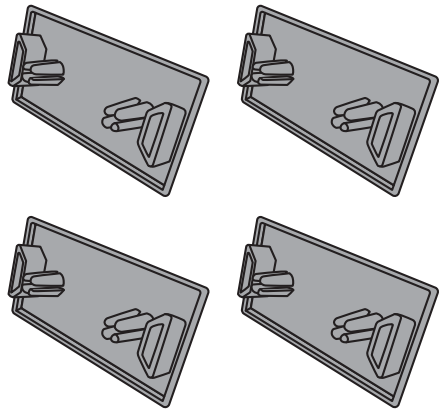

Foot Pad x 4

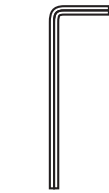

M4 Allen Key x 1

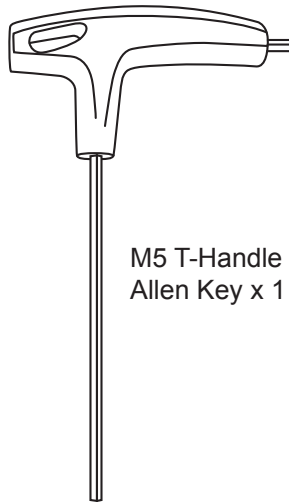

M5 T-Handle Allen Key x 1



Front Panel Safety Screw x 1

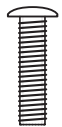

M5-Long Screw x 40



M5 Washer x 40

Accessories for connecting display cases

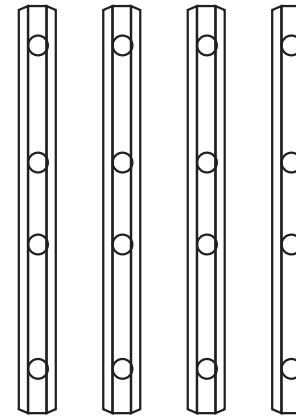

Stacking Bracket x 4

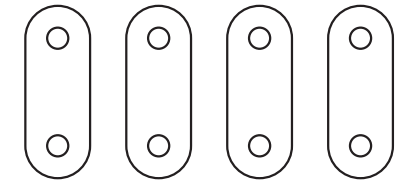

Horizontal Bracket x 4



M5 Nuts x 8



M4 Stacking Screw x 8



M5-Short Screw x 8



Attention: If you are connecting multiple display cases, please refer to "Connecting Display Cases" assembly guide before commencing.

Plexiglass Side Panel x 2

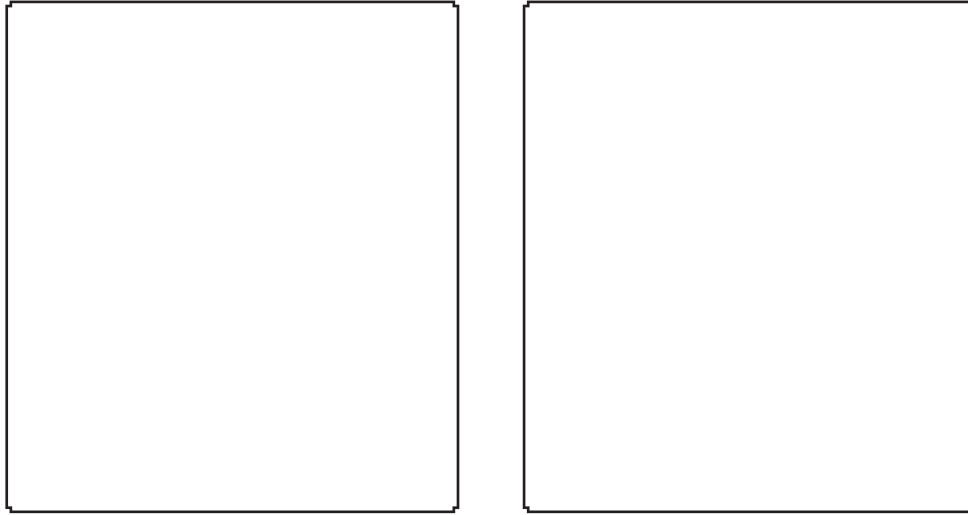

Plexiglass Front Panel x 1

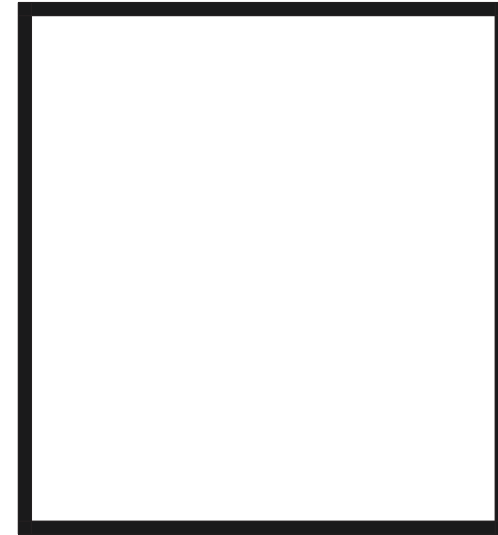

Back Panel x 2

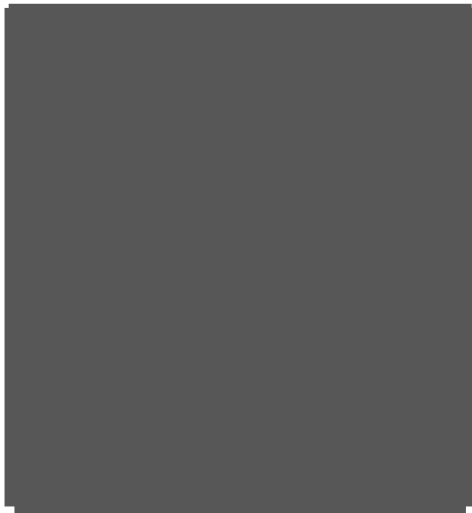

Top Panel x 2



Laminate Base x 1

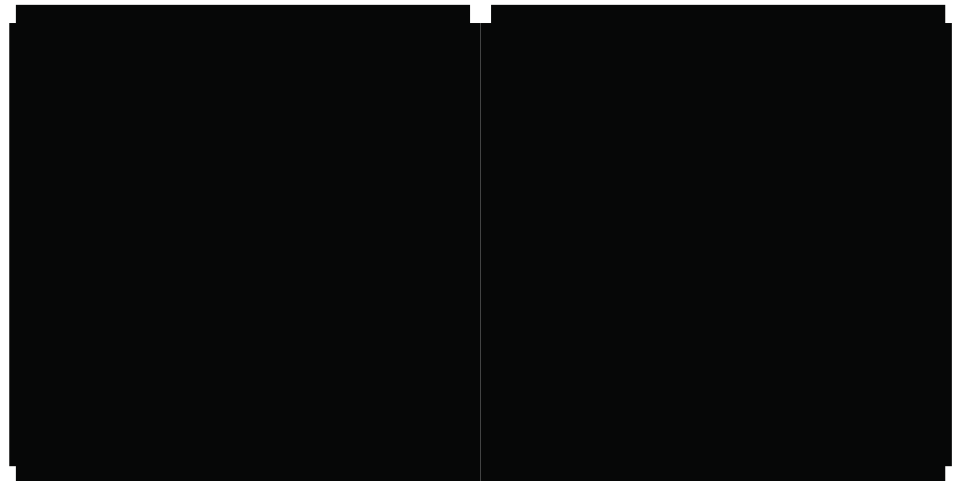

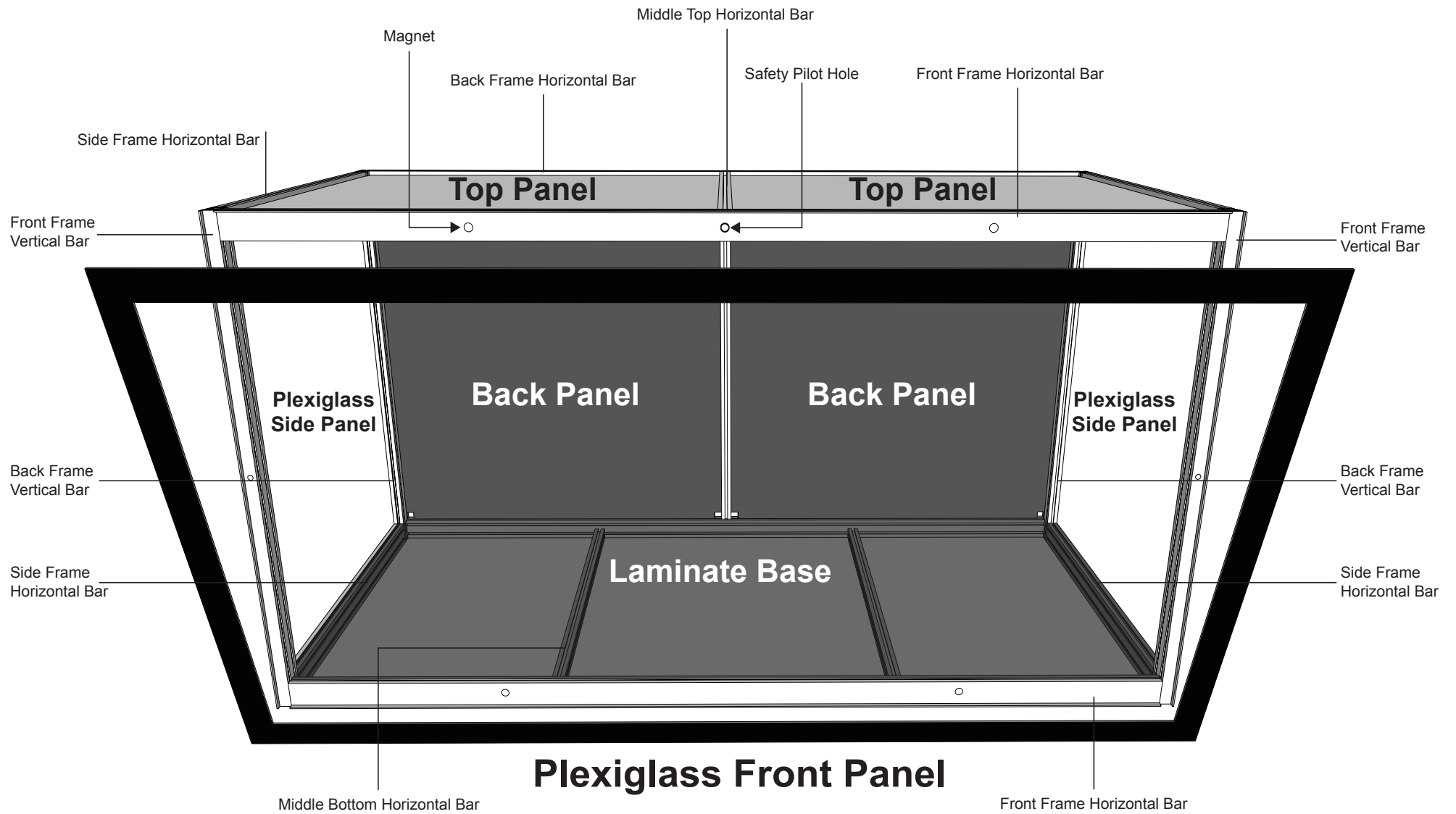

You will need

- Side Frame Horizontal Bar x 4
- Back Frame Vertical Bar x 2
- Front Frame Vertical Bar x 2
- Horizontal C-Channel x 4
- Vertical C-Channel x 4

Steps to install C-Channel

- Step 1.** Flatten one end of the C-Channel by pressing the open edges together.
- Step 2.** Push the compressed tip into the slit of the bar.
- Step 3.** Press down the rest of the C-Channel.

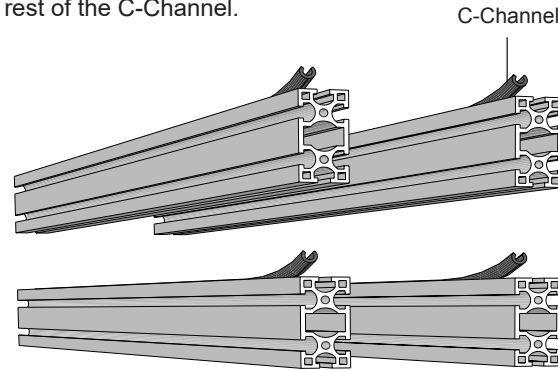

Side Frame Horizontal Bar

Position the bar on any side. Install a Horizontal C-Channel into the top slit of the bar. Repeat for all bars.

Back Frame Vertical Bar

Position the bar with the pilot holes facing the flat surface. Install a Vertical C-Channel into the top slit of the bar. Repeat for all bars.

⚠ If you are joining the display cases horizontally, do not insert the C-Channel on the connecting bar.

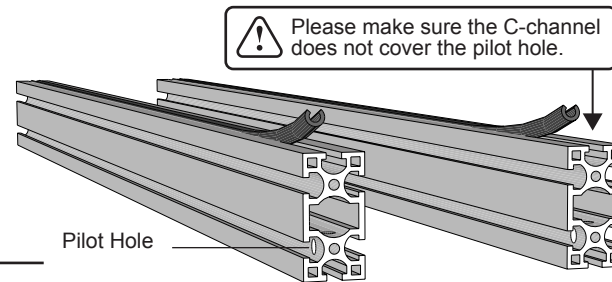

Front Frame Vertical Bar

Place a bar with the magnets facing down. Install a Vertical C-Channel into the top slit. Repeat for all bars.

⚠ If you are joining the display cases horizontally, do not insert the C-Channel on the connecting bar.

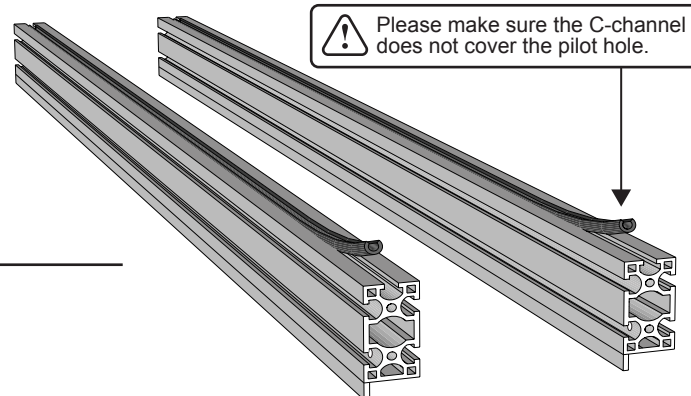

You will need

- M5-Long Screw x 40
- M5-Washer x 40
- Side Frame Horizontal Bar x 4
- Middle Top Horizontal Bar x 1
- Middle Bottom Horizontal Bar x 2
- Back Frame Middle Vertical Bar x 1
- Back Frame Horizontal Bar x 2
- Front Frame Horizontal Bar x 2

Steps to insert M5-Long Screw

- Step 1.** Insert the M5-Long Screw fully into the M5-Washer.
- Step 2.** Position the screw with washer into the pilot hole on the left side of the bar. Turn clockwise to tighten the screw. Leave a 15mm gap between the washer and bar.
- Step 3.** Repeat steps 1-2 for the other side of the bar.
- Step 4.** Repeat steps 1-3 for
- Side Frame Horizontal Bar x 4
 - Middle Top Horizontal Bar x 1
 - Middle Bottom Horizontal Bar x 2
 - Back Frame Middle Vertical Bar x 1
 - Back Frame Horizontal Bar x 2
 - Front Frame Horizontal Bar x 2

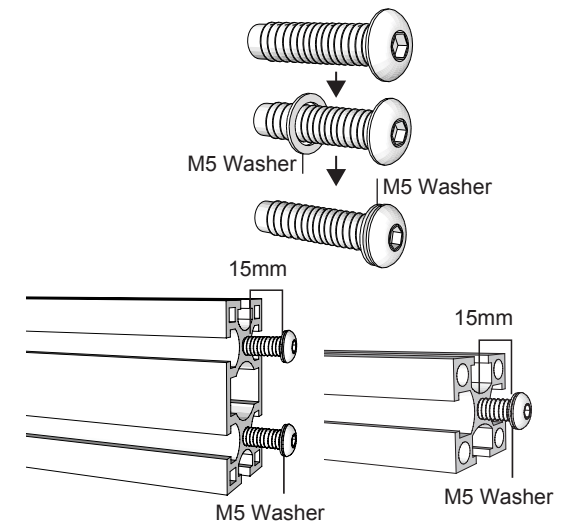

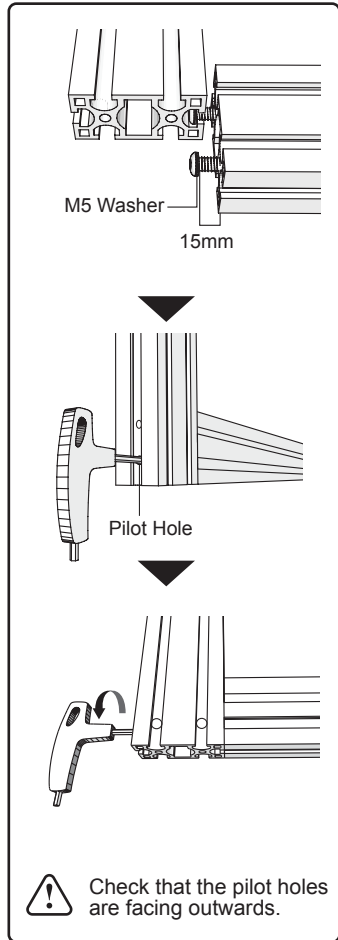

Step 1.
Connect Back Frame Vertical Bar to Side Frame Horizontal Bar. Tighten the connecting screw using the T-Allen Key.

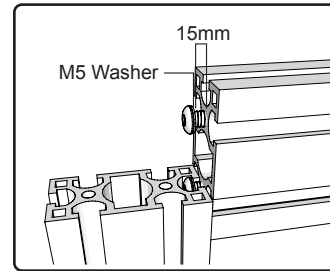
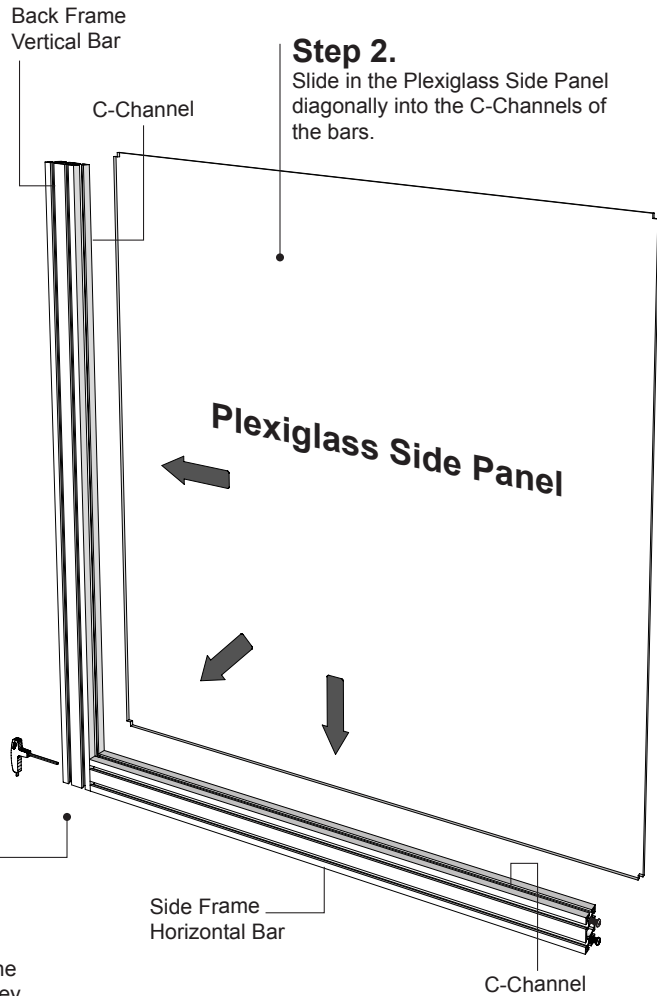

Step 4.
Press down the Side Frame Horizontal Bar into the Plexiglass Side Panel. Tighten the connecting screw using the T-Allen Key.

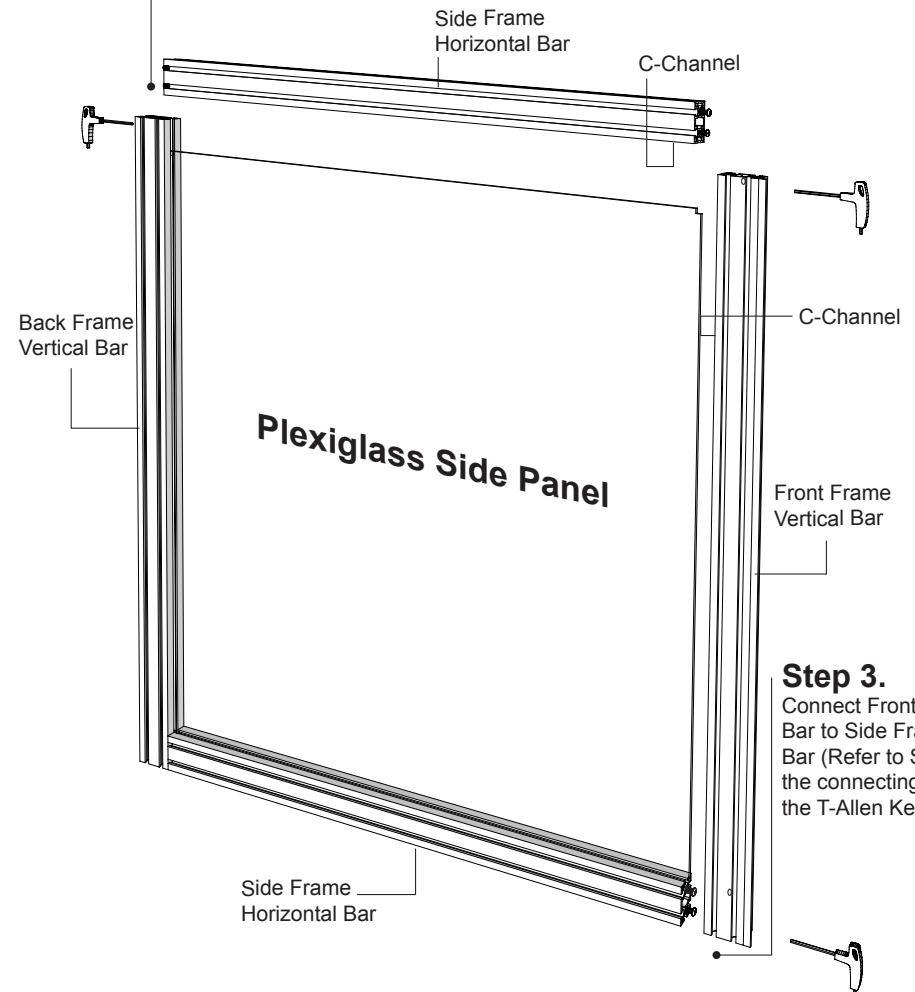

Step 3.
Connect Front Frame Vertical Bar to Side Frame Horizontal Bar (Refer to Step 1). Tighten the connecting screw using the T-Allen Key.

Step 6.

Slide in the Plexiglass Side Panel diagonally into the C-Channels of the bars.

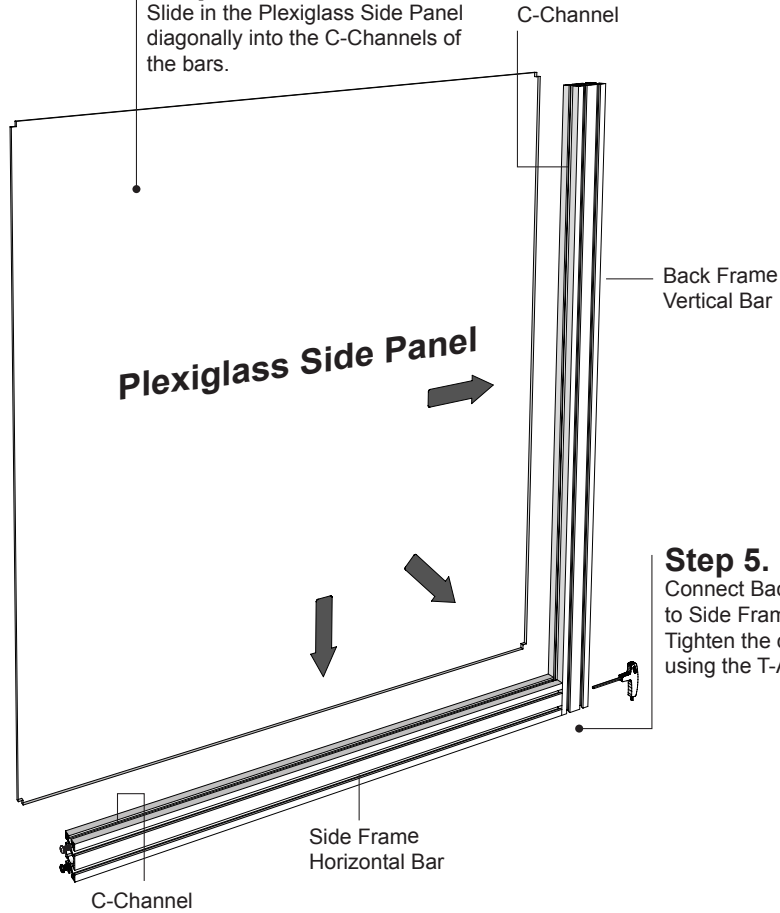

Step 5.

Connect Back Frame Vertical Bar to Side Frame Horizontal Bar. Tighten the connecting screw using the T-Allen Key.

Step 8.

Press down the Side Frame Horizontal Bar into the Plexiglass Side Panel. Tighten the connecting screw using the T-Allen Key.

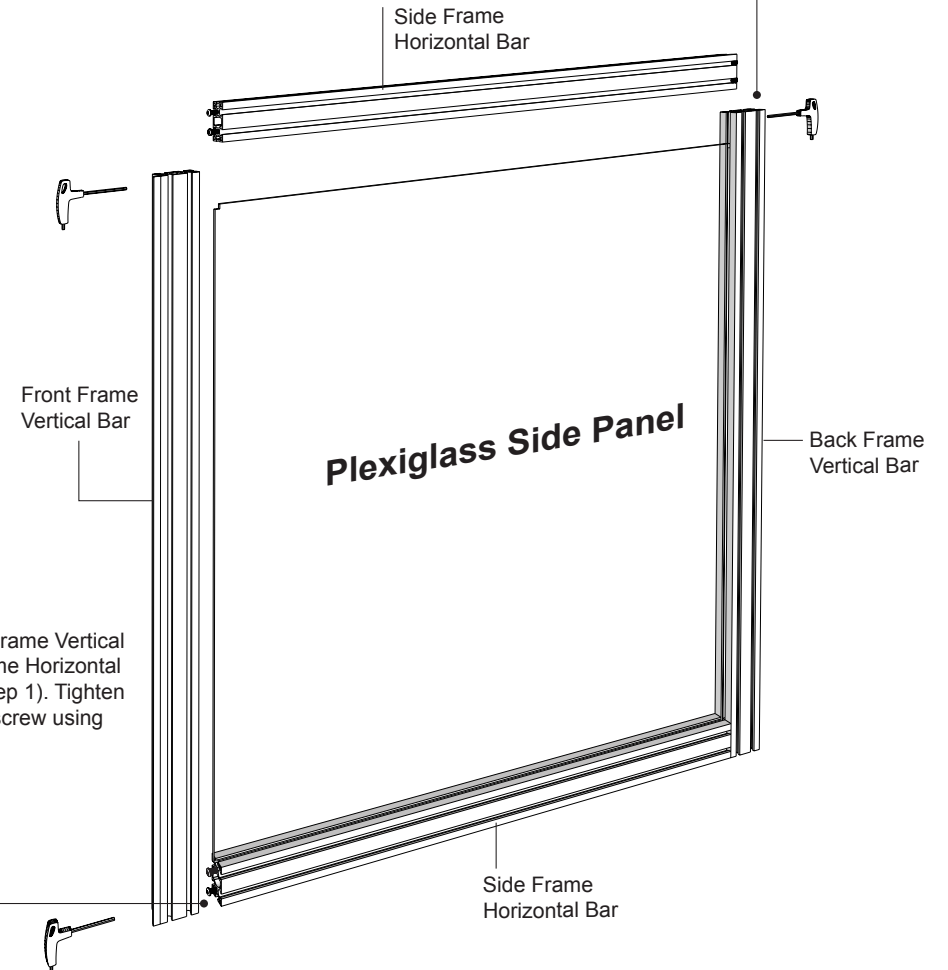
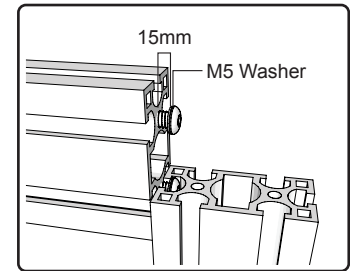

Step 7.

Connect Front Frame Vertical Bar to Side Frame Horizontal Bar (Refer to Step 1). Tighten the connecting screw using the T-Allen Key.

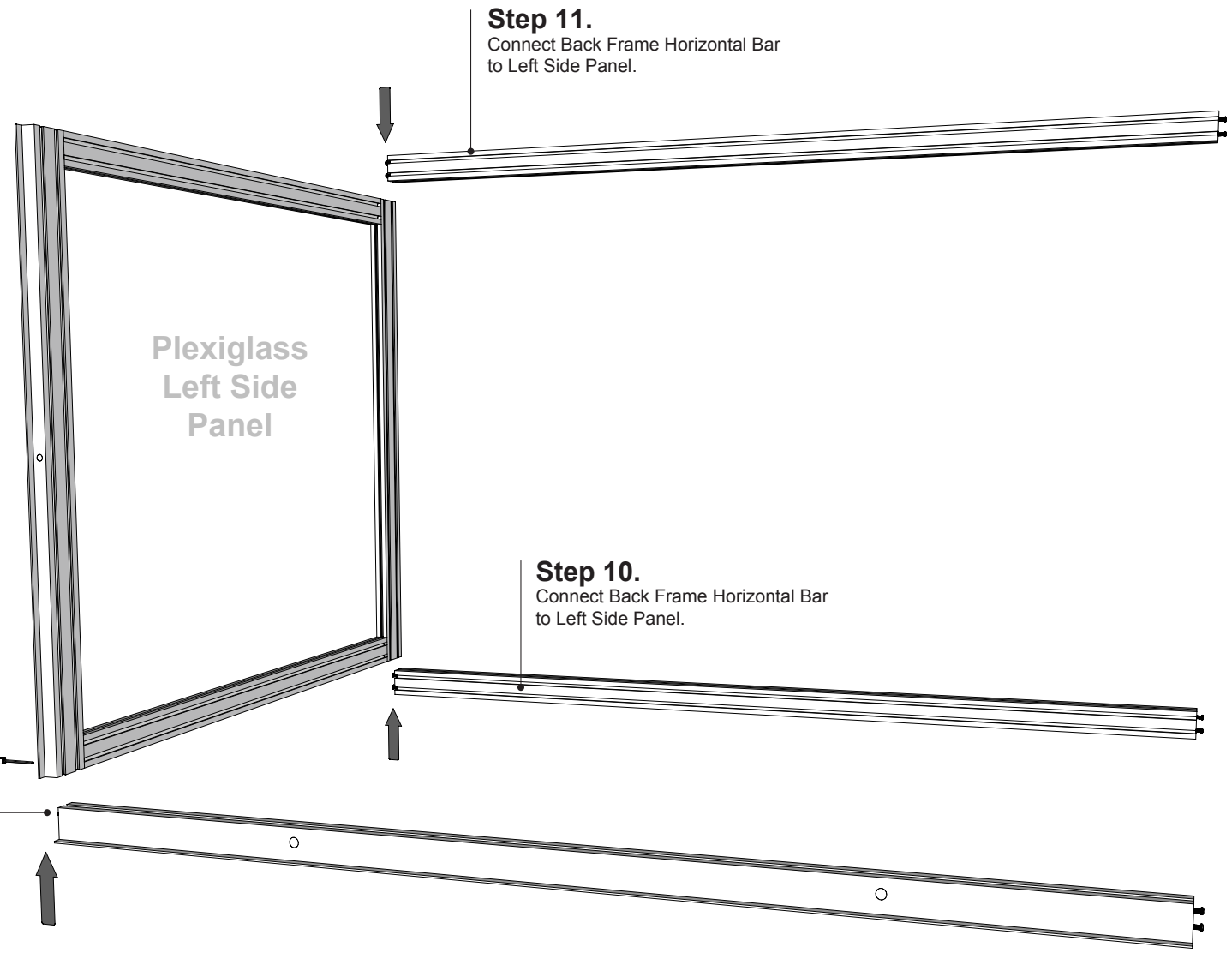

Step 11.
Connect Back Frame Horizontal Bar to Left Side Panel.

Step 10.
Connect Back Frame Horizontal Bar to Left Side Panel.

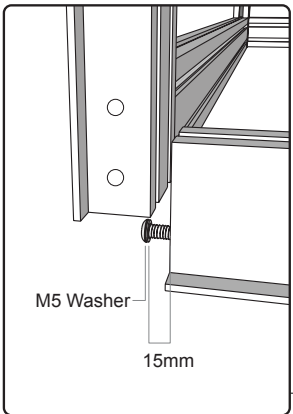

Step 9.
Connect Front Frame Horizontal Bar to Left Side Panel.

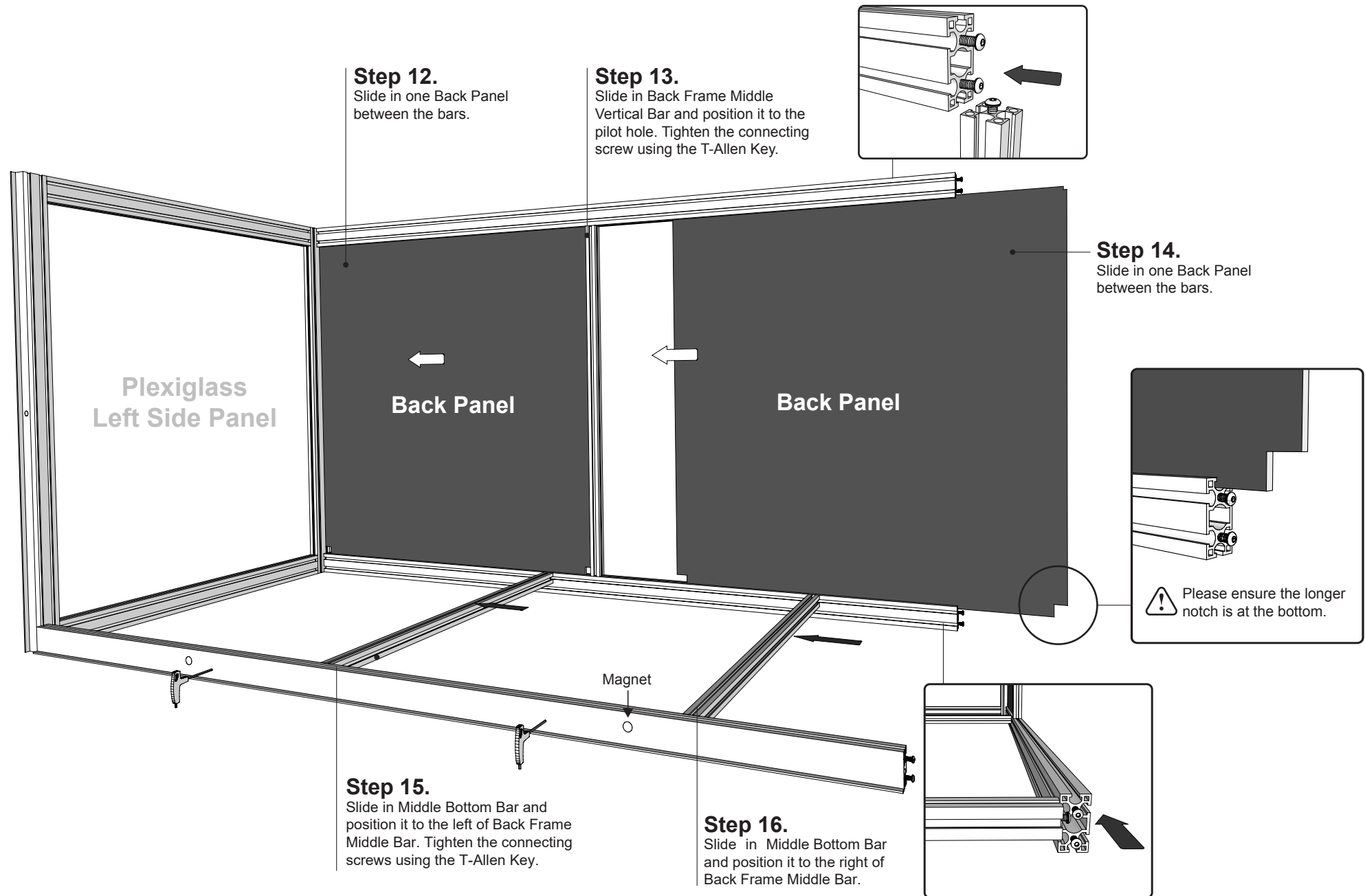

Step 12.
Slide in one Back Panel between the bars.

Step 13.
Slide in Back Frame Middle Vertical Bar and position it to the pilot hole. Tighten the connecting screw using the T-Allen Key.

Step 14.
Slide in one Back Panel between the bars.

Plexiglass
Left Side Panel

Back Panel

Back Panel

Magnet

⚠ Please ensure the longer notch is at the bottom.

Step 15.
Slide in Middle Bottom Bar and position it to the left of Back Frame Middle Bar. Tighten the connecting screws using the T-Allen Key.

Step 16.
Slide in Middle Bottom Bar and position it to the right of Back Frame Middle Bar.

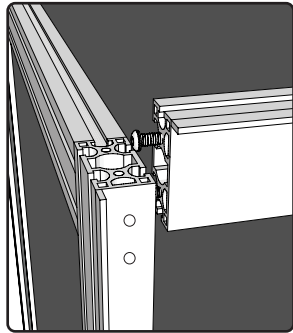

Step 17.
Connect Front Frame Horizontal Bar to Front Frame Vertical bar.

Step 18.
Slide in a Top Panel between the bars.

Step 19.
Slide in a Middle Top Horizontal Bar between the bars and position it to align with Back Frame Middle Vertical Bar.

Step 20.
Slide in a Top Panel between the bars.

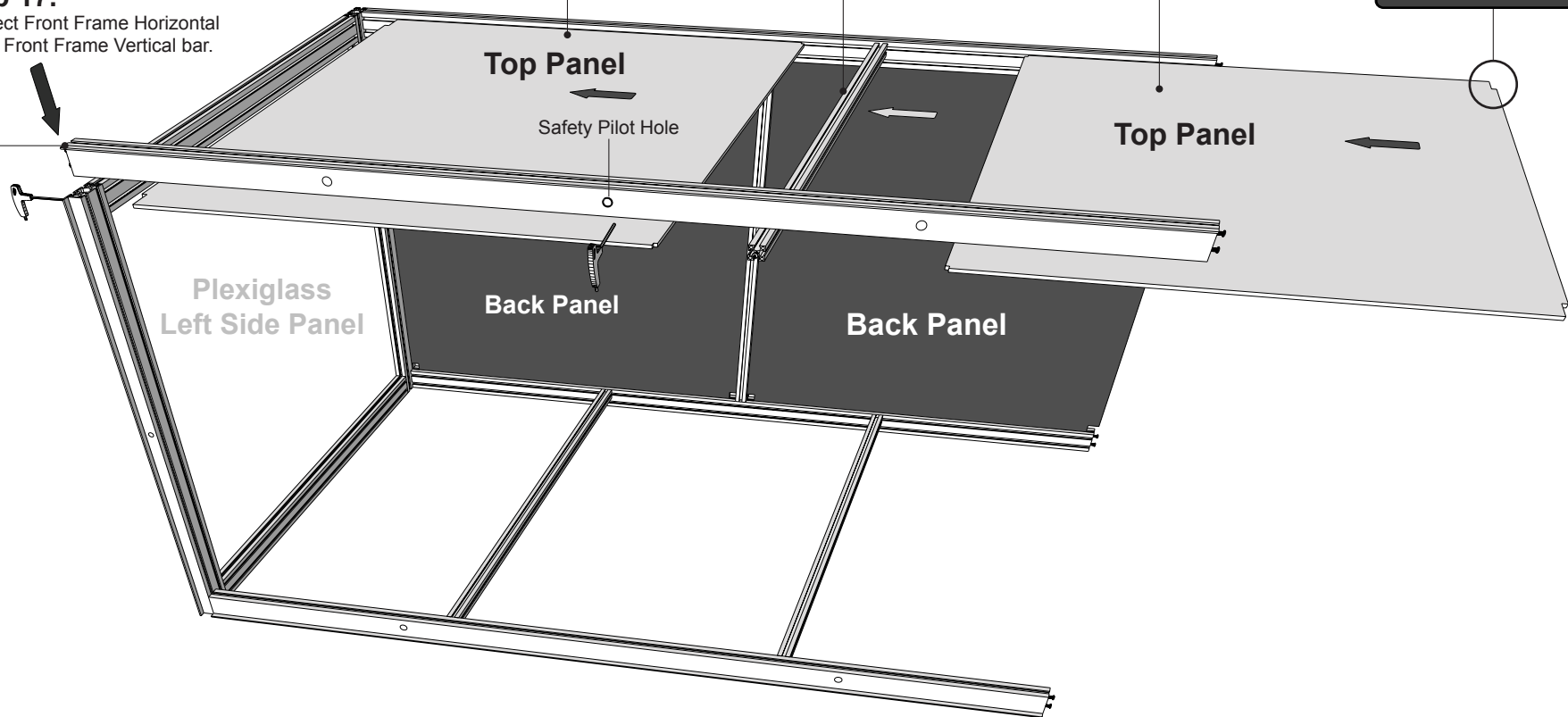
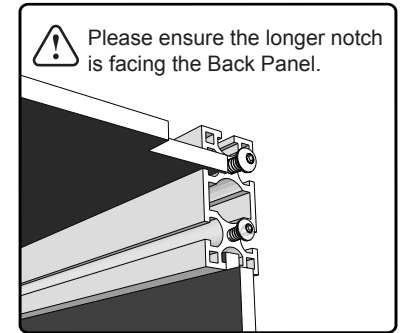

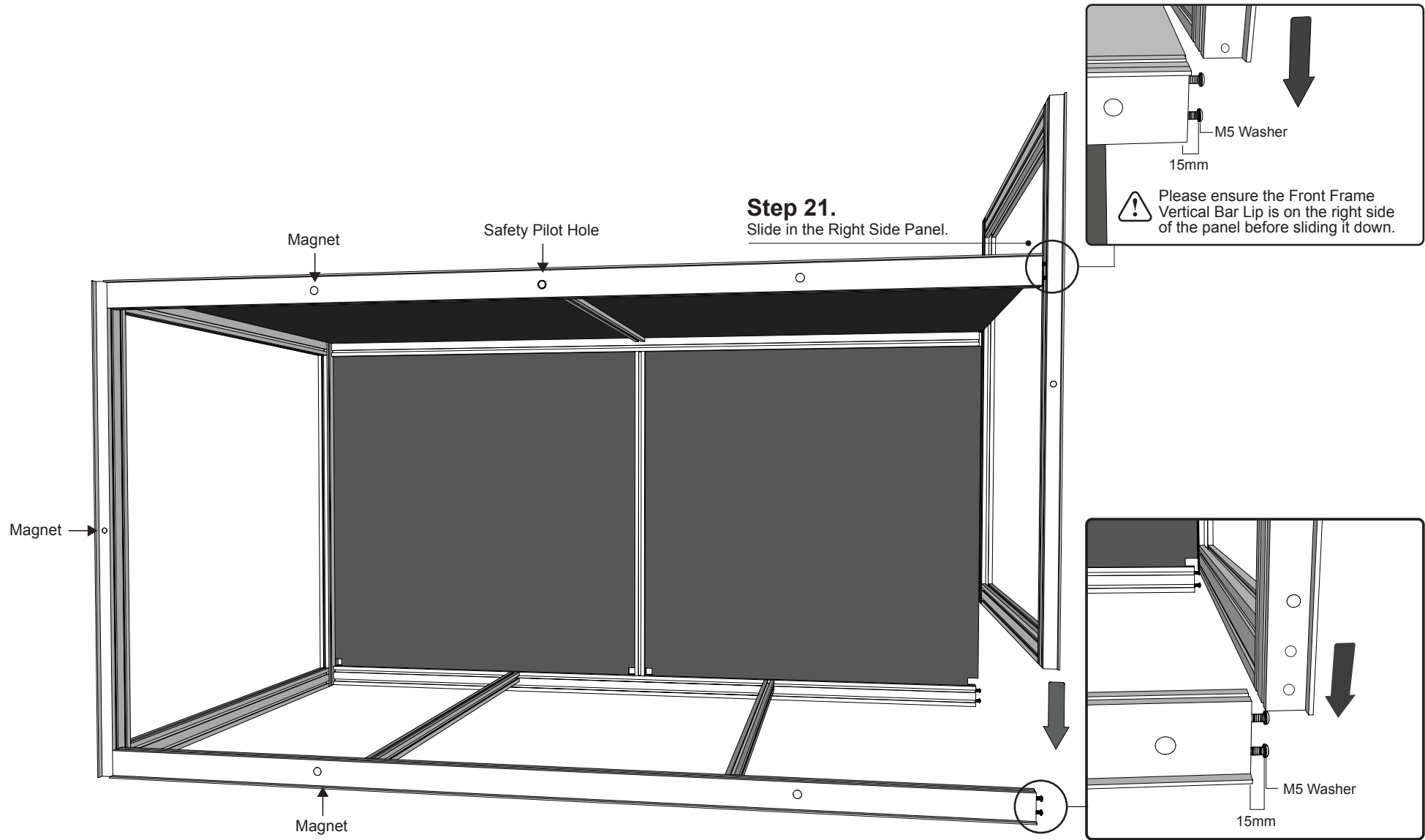

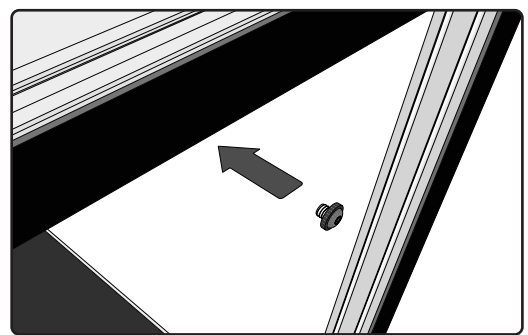
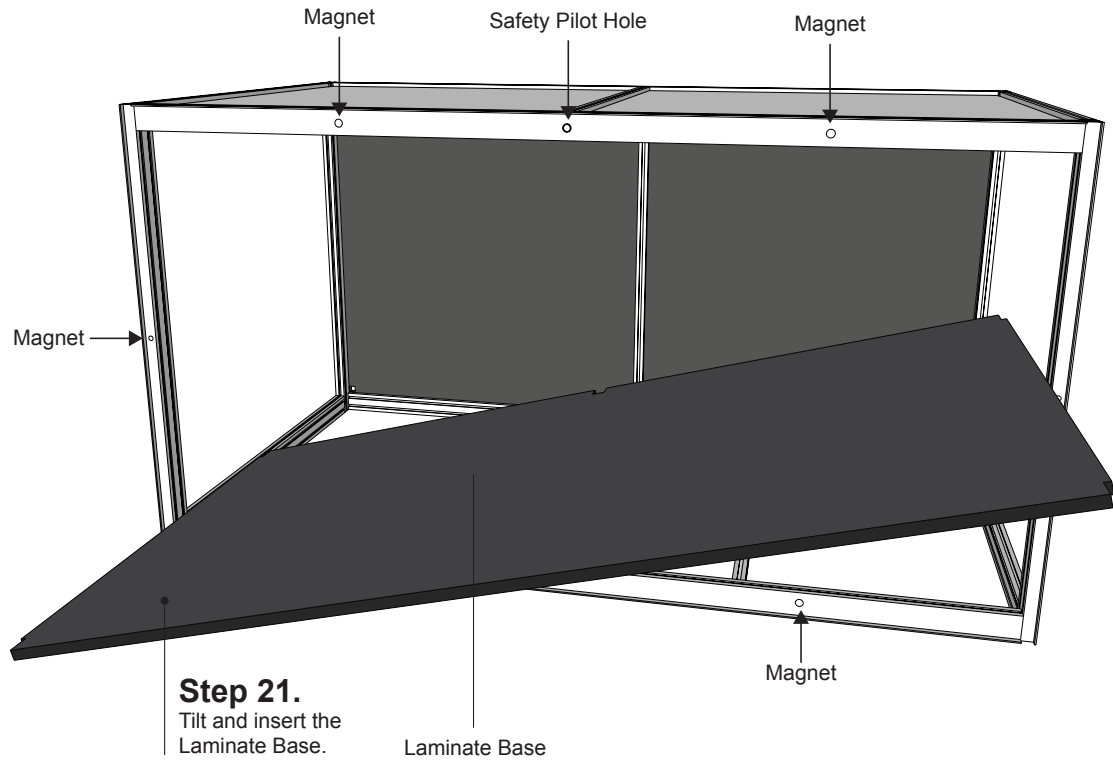

Step 22.
Attach the Plexiglass Front Panel and insert the Safety Screw.

