



**MODU
SPACE**

Bespoke Showcase Engineers

DF130 Assembly Guide

Version 3.0

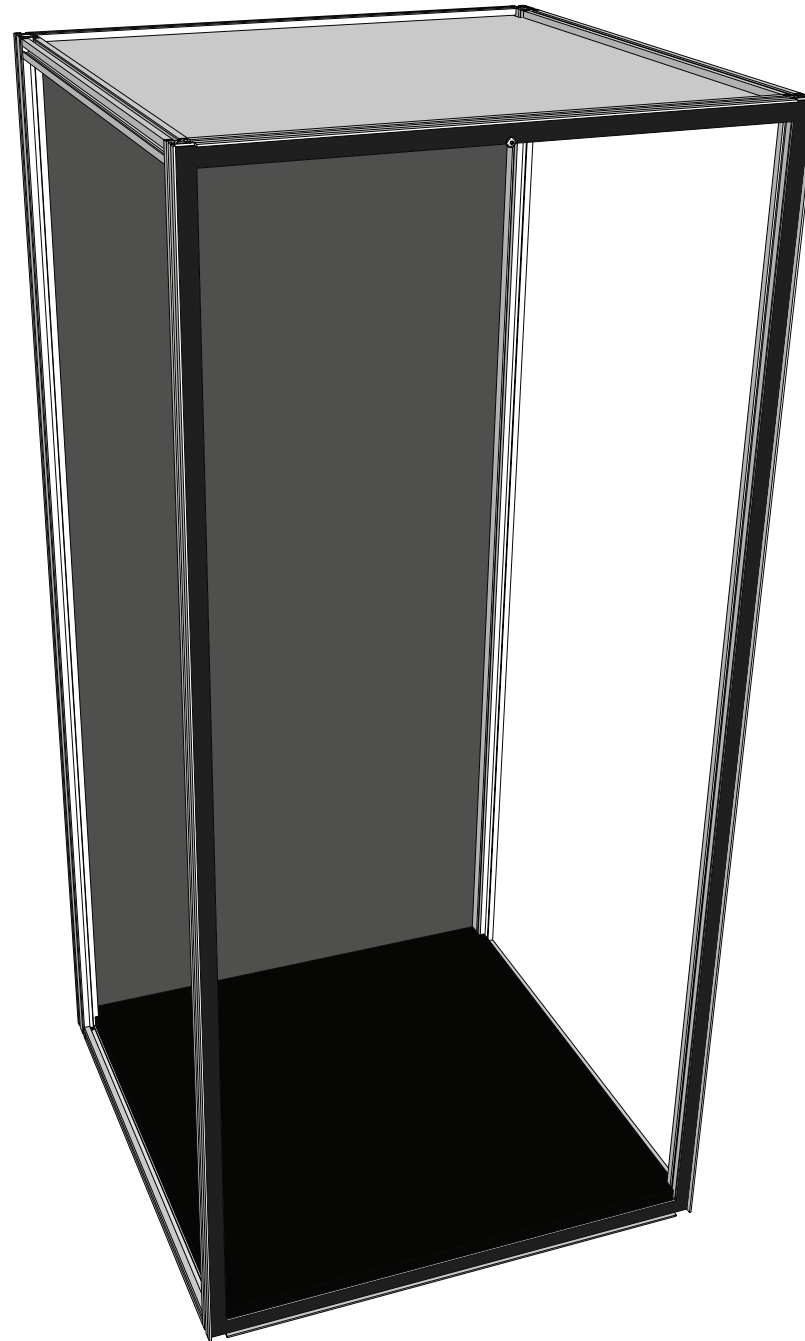

Back Frame
Vertical Bar x 2

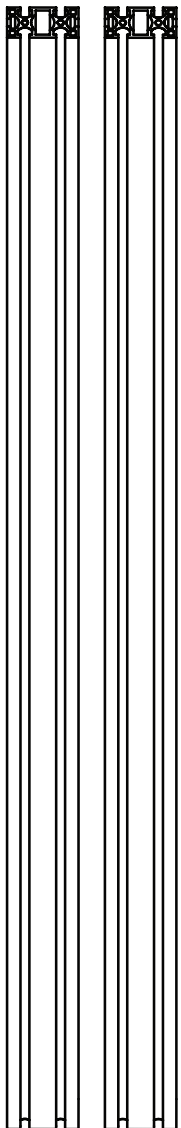

Back Frame
Horizontal Bar x2

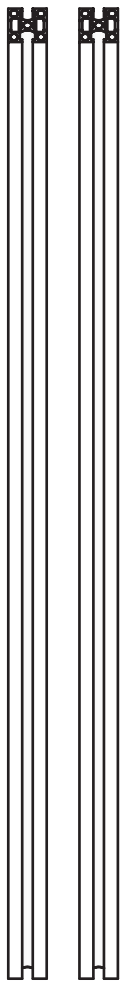

Front Frame
Vertical Bar x 2

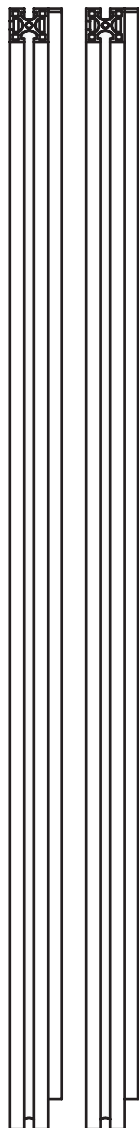

Front Frame
Horizontal Bar x 2

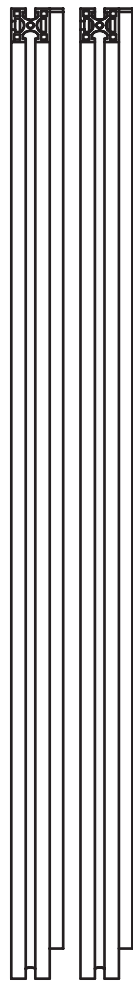

Side Frame
Horizontal Bar x 4

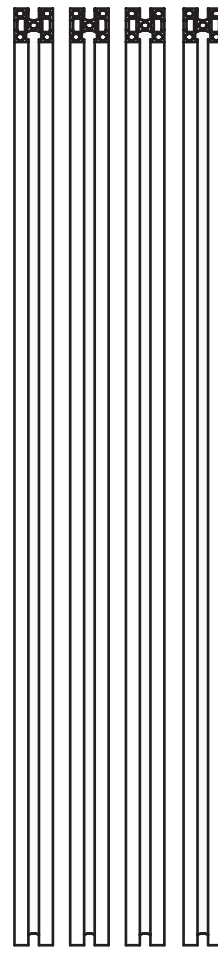

Vertical
C-Channel x 4



Horizontal
C-Channel x 4



Conduits x 2



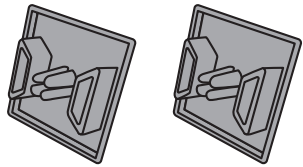

Front Frame Foot Pad x 2

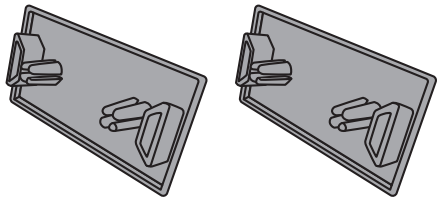

Back Frame Foot Pad x 2



M5-Long Screw x 16



M5 Washer x 16



M4 Allen Key x 1



Front Panel Safety Screw x 1

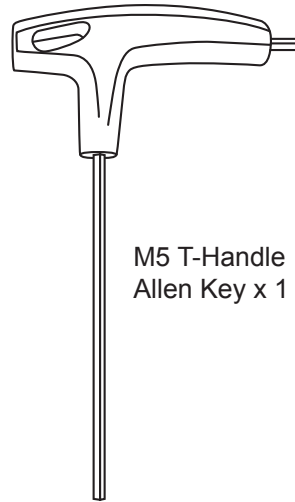

M5 T-Handle Allen Key x 1

Accessories for connecting display cases

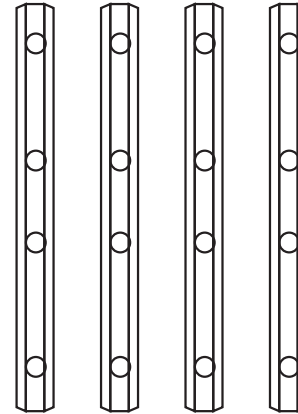

Stacking Bracket x 4

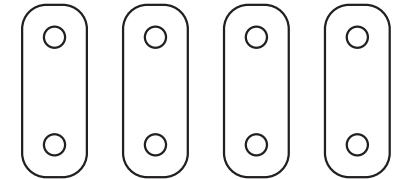

Horizontal Bracket x 4



M5 Nuts x 8



M4 Stacking Screw x 8



M5-Short Screw x 8



Attention: If you are connecting multiple display cases, please refer to "Connecting Display Cases" assembly guide before commencing.

Plexiglass Front Panel x 1

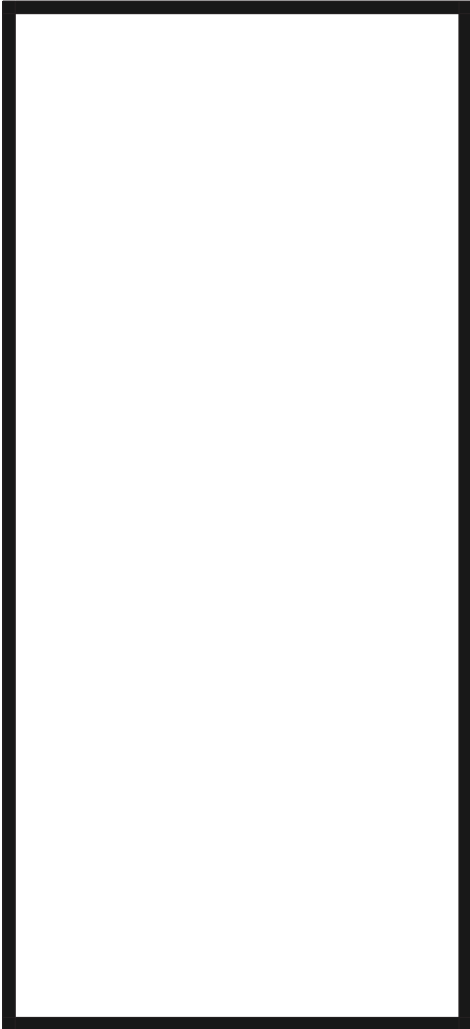

Back Panel x 1

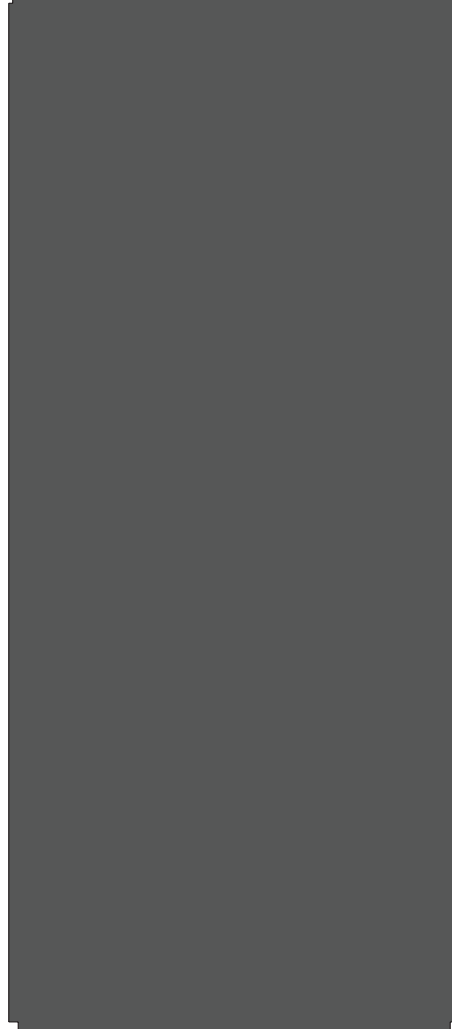

Plexiglass Side Panel x 2

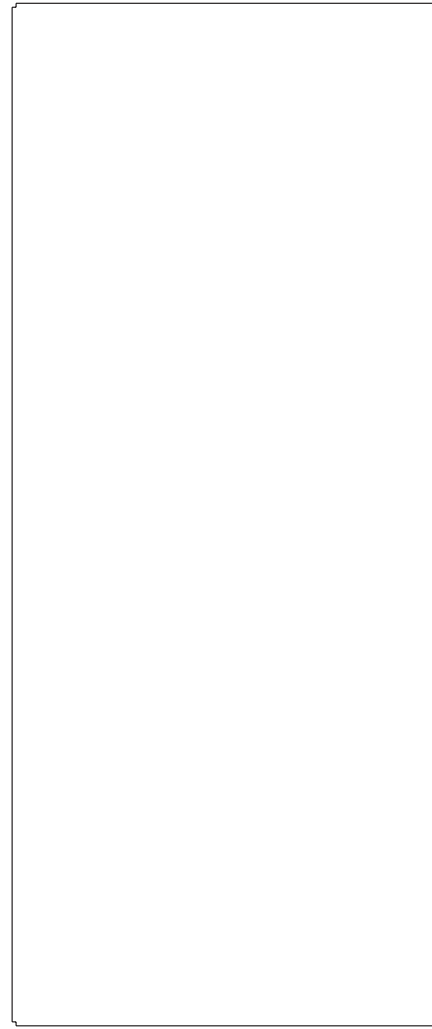

Laminate Base x 1

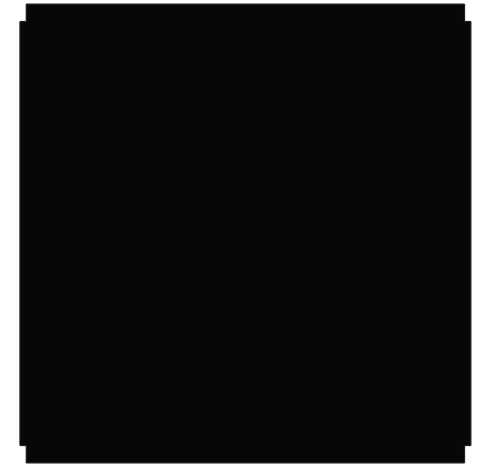

Top Panel x 1



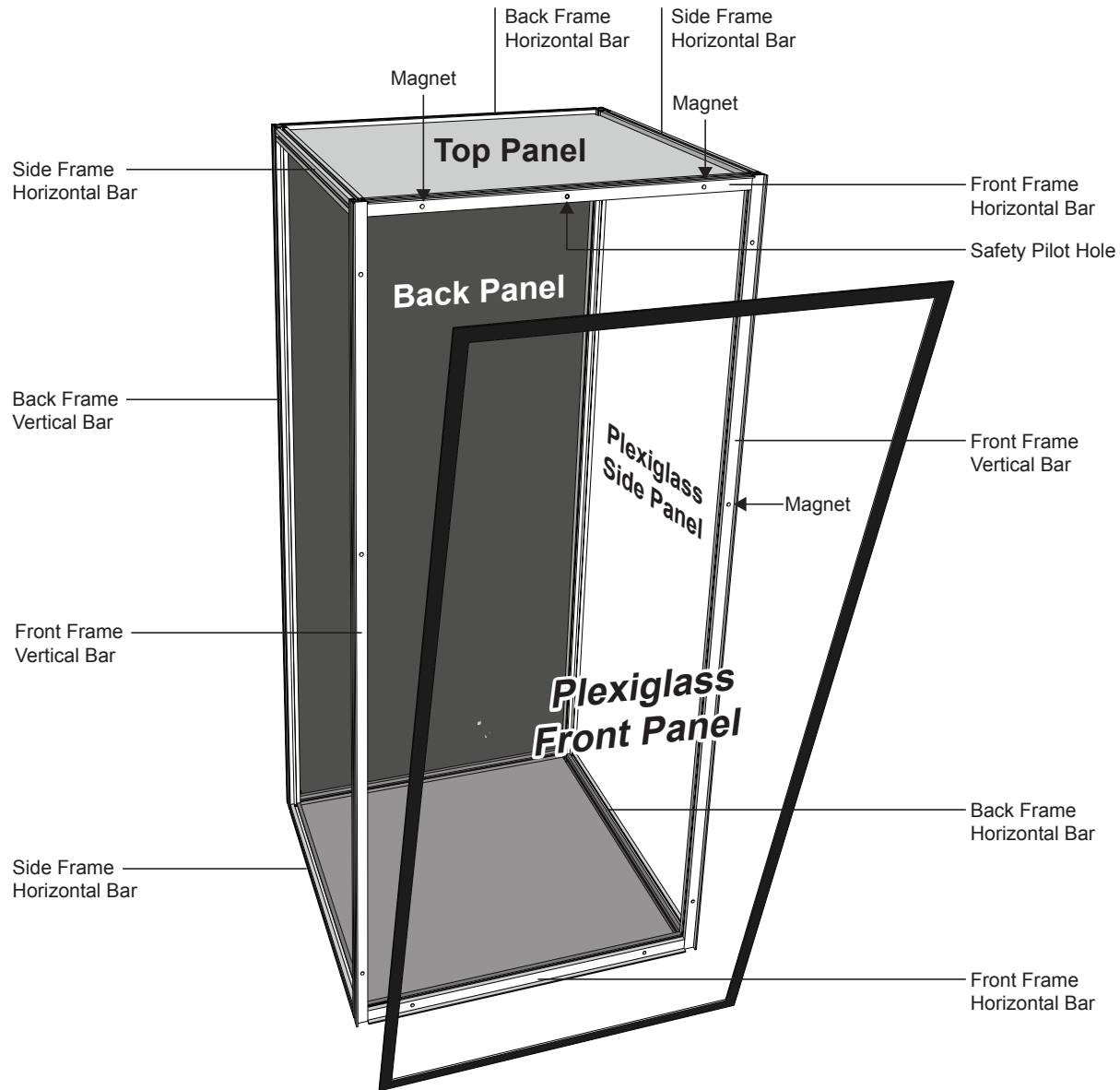

⚠ Attention: If you have a floor that could easily scratched or damaged, please ensure you cover the surface with a protective cover.

⚠ Attention: Please ensure you have all the parts before commencing assembly. Please read all of the instructions before commencing.

⚠ Attention: If you have purchased optional accessories, please refer to the **Optional Accessories** assembly instructions which are supplied separately.

You will need

- Side Frame Horizontal Bar x 4
- Back Frame Vertical Bar x 2
- Front Frame Vertical Bar x 2
- Horizontal C-Channel x 4
- Vertical C-Channel x 4

Steps to install C-Channel

- Step 1.** Flatten one end of the C-Channel by pressing the open edges together.
- Step 2.** Push the compressed tip into the slit of the bar.
- Step 3.** Press down the rest of the C-Channel along the slit of the bar.

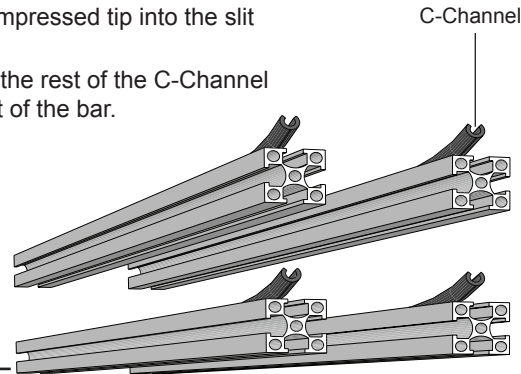

Side Frame Horizontal Bar

Position the bar on any side. Install a Horizontal C-Channel into the top slit of the bar. Repeat for all bars.

Back Frame Vertical Bar

Position the bar with the pilot holes facing the flat surface. Install a Vertical C-Channel into the top slit of the bar. Repeat for all bars.

⚠ If you are joining the display cases horizontally, do not insert the C-Channel on the connecting bar.

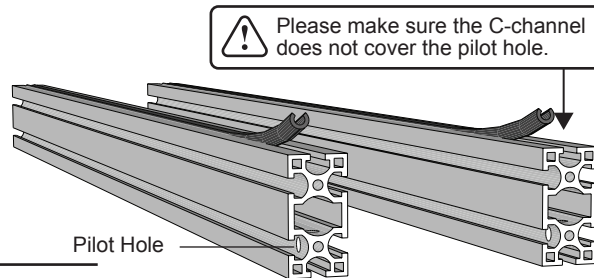

Front Frame Vertical Bar

Place a bar with the magnets facing down. Install a Vertical C-Channel into the top slit. Repeat for all bars.

⚠ If you are joining the display cases horizontally, do not insert the C-Channel on the connecting bar.

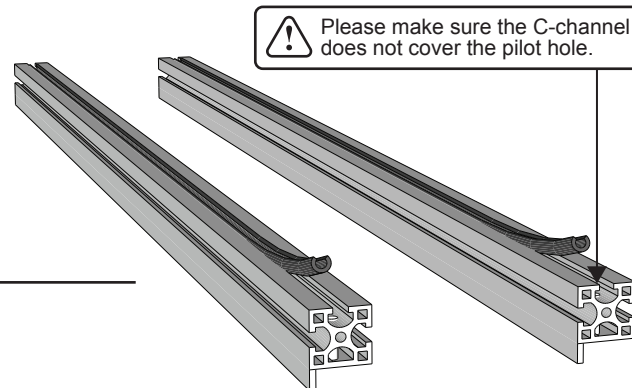

You will need

- M5-Long Screw x 16
- M5-Washer x 16
- Side Frame Horizontal Bar x 4
- Back Frame Horizontal Bar x 2
- Front Frame Horizontal Bar x 2

Steps to insert M5-Long Screw

- Step 1.** Insert the M5-Long Screw fully into the M5-Washer.
- Step 2.** Position the screw with washer into the pilot hole on the left side of the bar. Turn clockwise to tighten the screw. Leave a 15mm gap between the washer and bar.
- Step 3.** Repeat steps 1-2 for the other side of the bar.
- Step 4.** Repeat steps 1-3 for
- Side Frame Horizontal Bar x 4
 - Front Frame Horizontal Bar x 2
 - Back Frame Horizontal Bar x 2

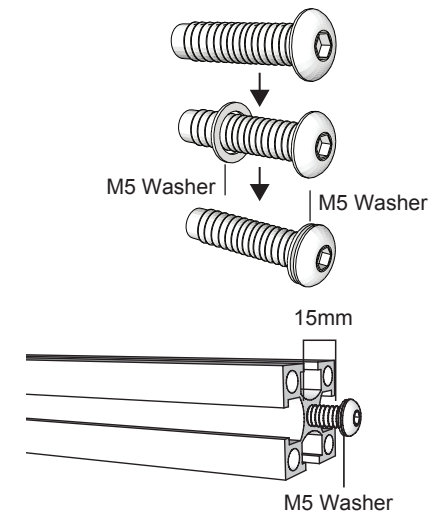

Step 1.

Connect Back Frame Vertical Bar to Side Frame Horizontal Bar. Tighten the connecting screw using the T-Allen Key.

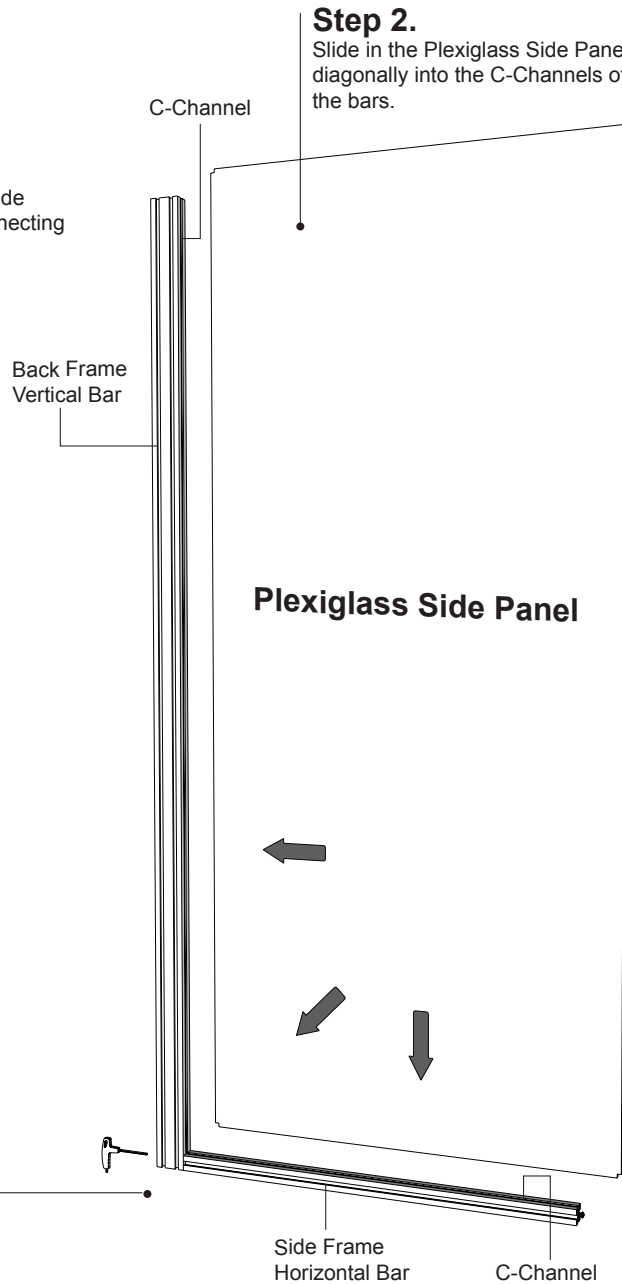
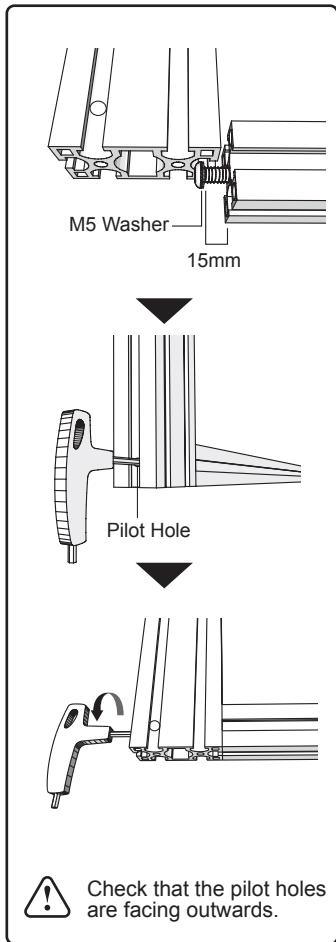

Step 2.

Slide in the Plexiglass Side Panel diagonally into the C-Channels of the bars.

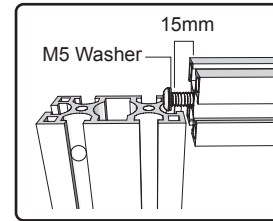

Step 4.

Press down the Side Frame Horizontal Bar into the Plexiglass Side Panel. Tighten the connecting screw using the T-Allen Key.

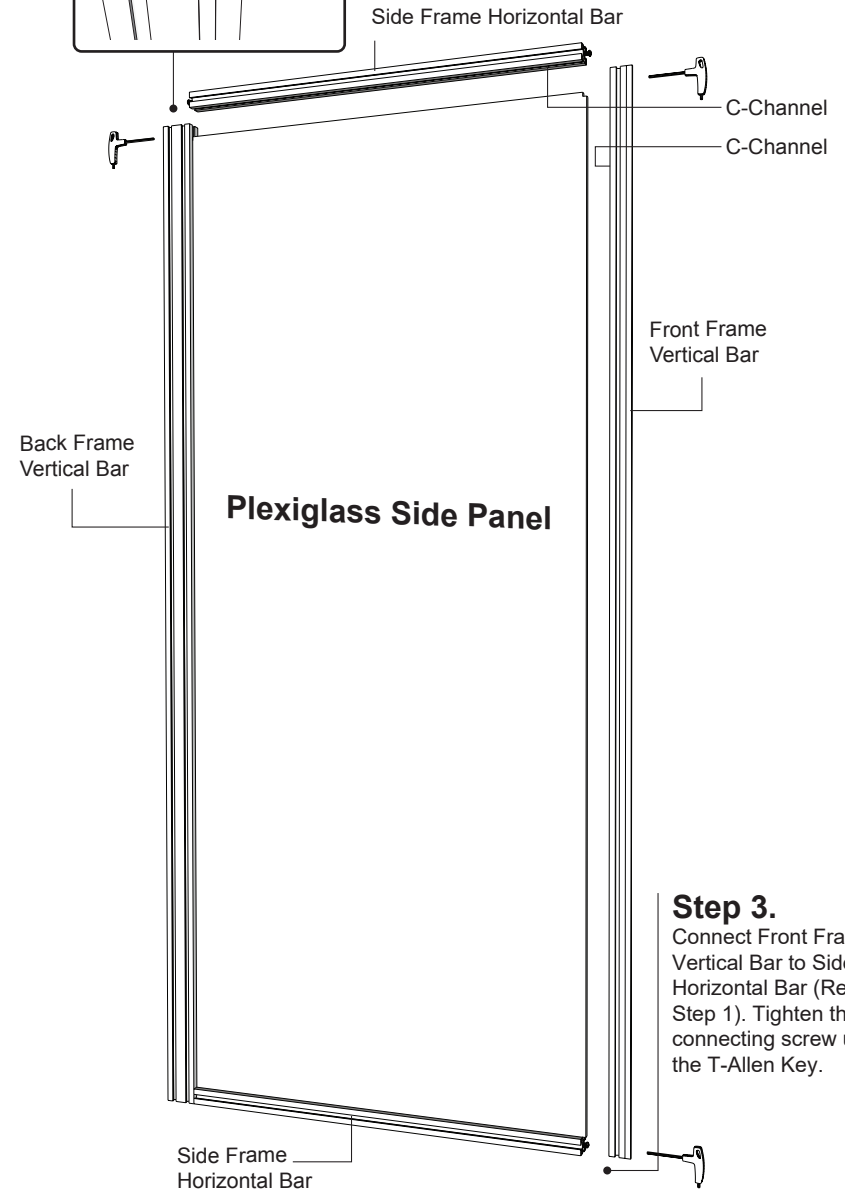

Step 3.

Connect Front Frame Vertical Bar to Side Frame Horizontal Bar (Refer to Step 1). Tighten the connecting screw using the T-Allen Key.

Step 6.

Slide in the Plexiglass Side Panel diagonally into the C-Channels of the bars.

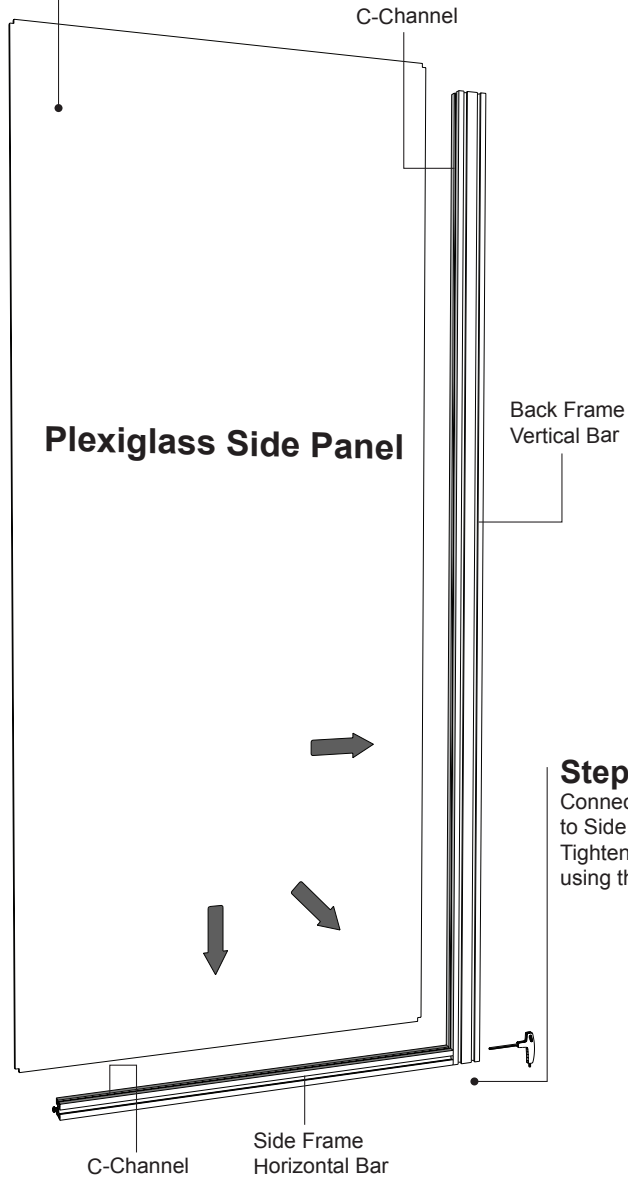

Step 5.

Connect Back Frame Vertical Bar to Side Frame Horizontal Bar. Tighten the connecting screw using the T-Allen Key.

Step 7.

Connect Front Frame Vertical Bar to Side Frame Horizontal Bar (Refer to Step 1). Tighten the connecting screw using the T-Allen Key.

Step 8.

Press down the Side Frame Horizontal Bar into the Plexiglass Side Panel. Tighten the connecting screw using the T-Allen Key.

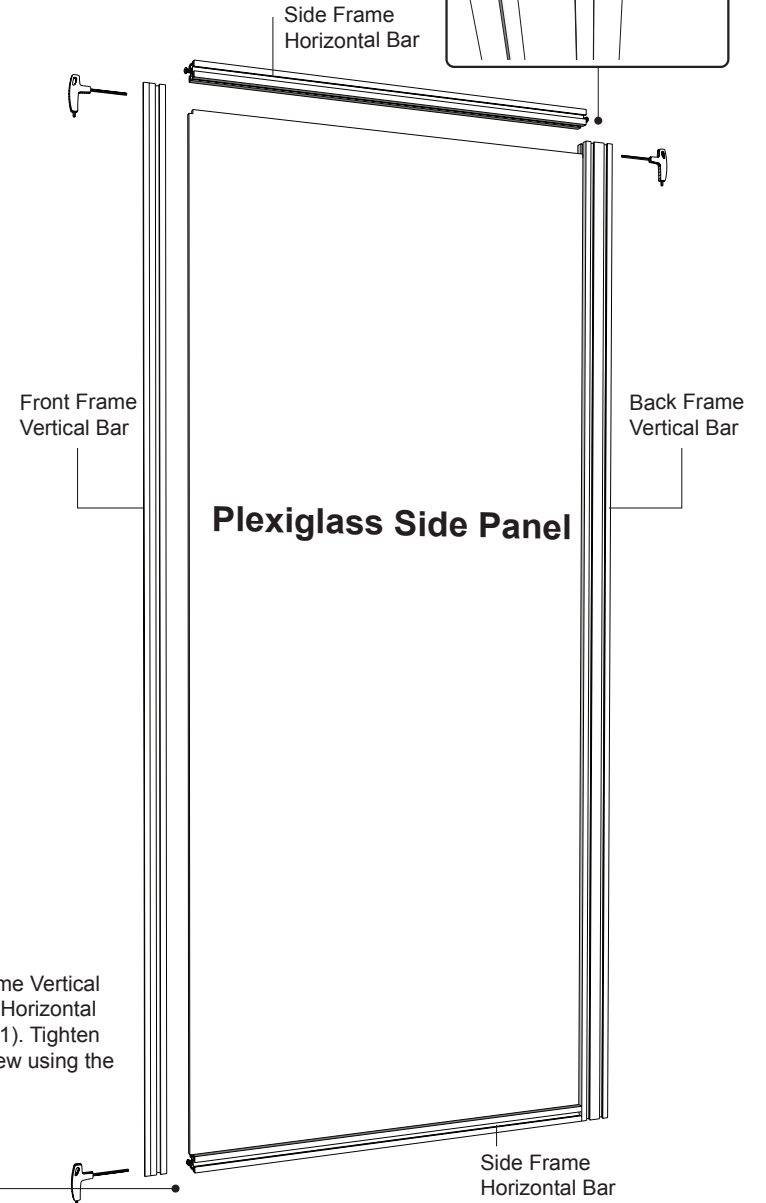
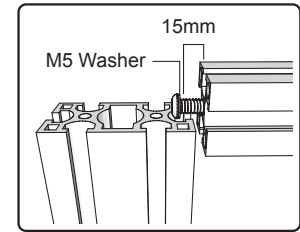

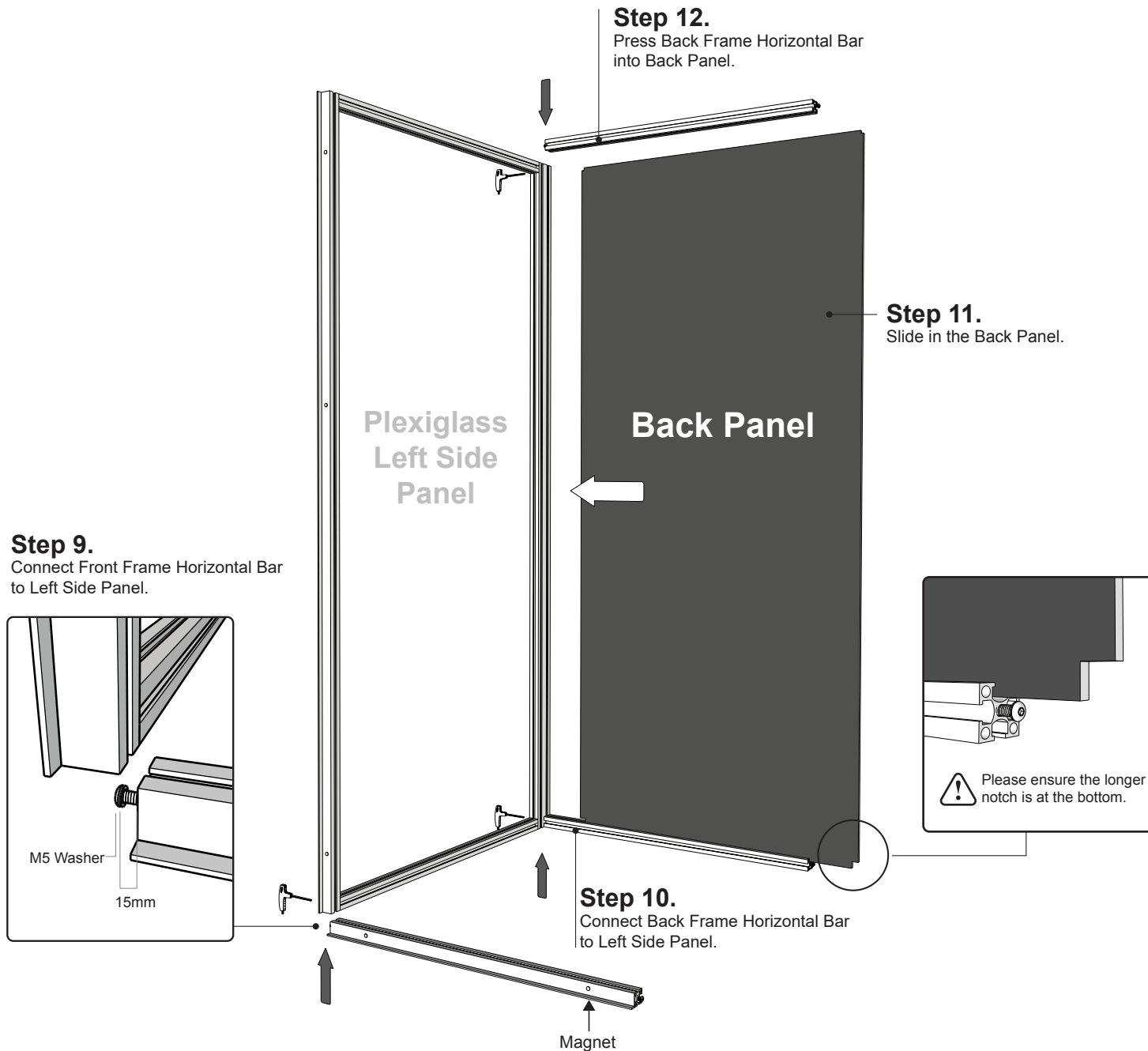

Step 13.
Connect Front Frame Horizontal Bar to Front Frame Vertical bar.

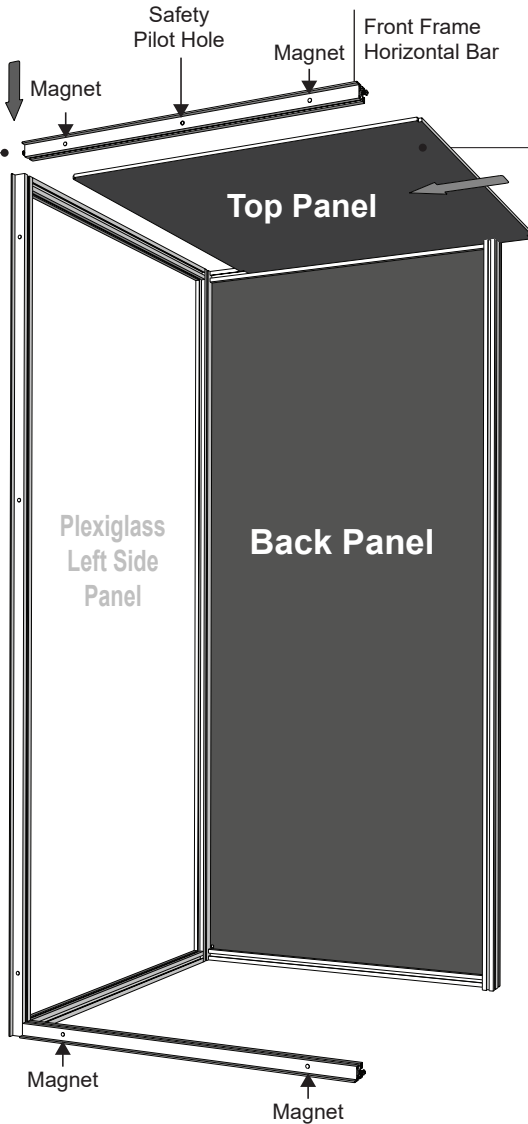
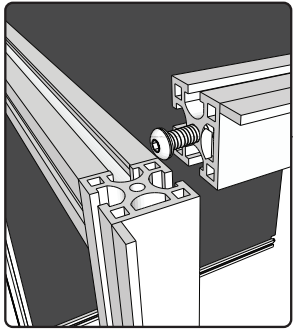

Step 14.
Slide in the Top Panel between the bars.

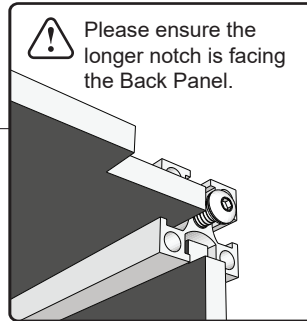

Step 15.
Slide in the Right Side Panel.

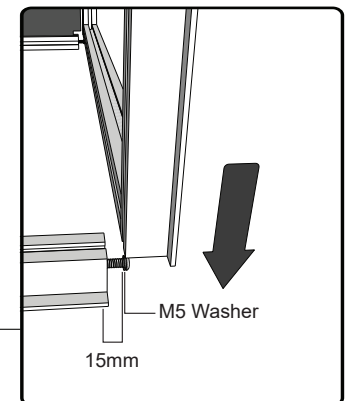
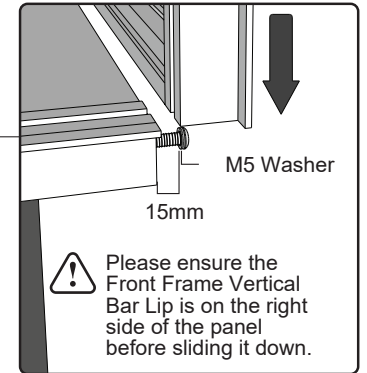
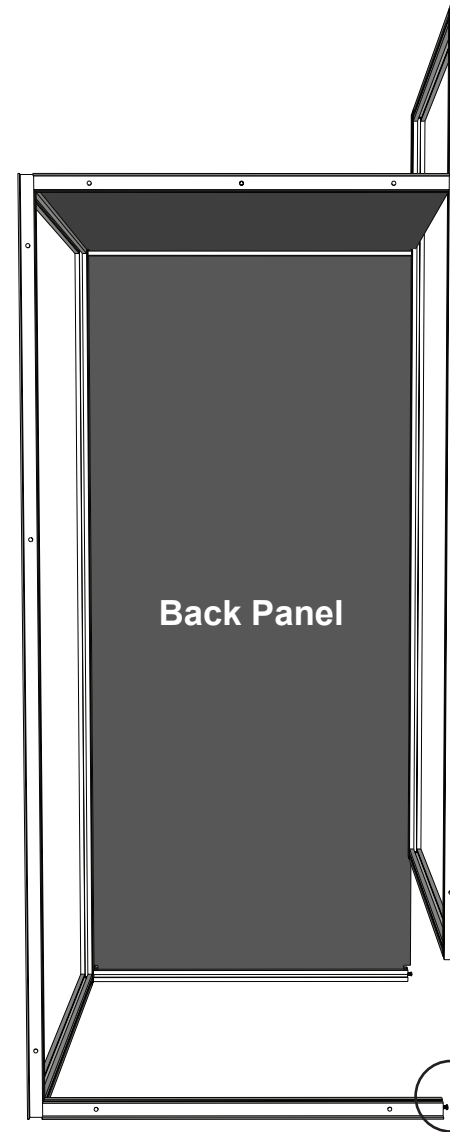

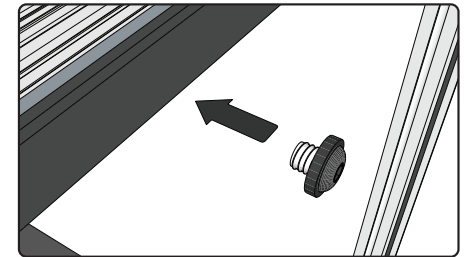
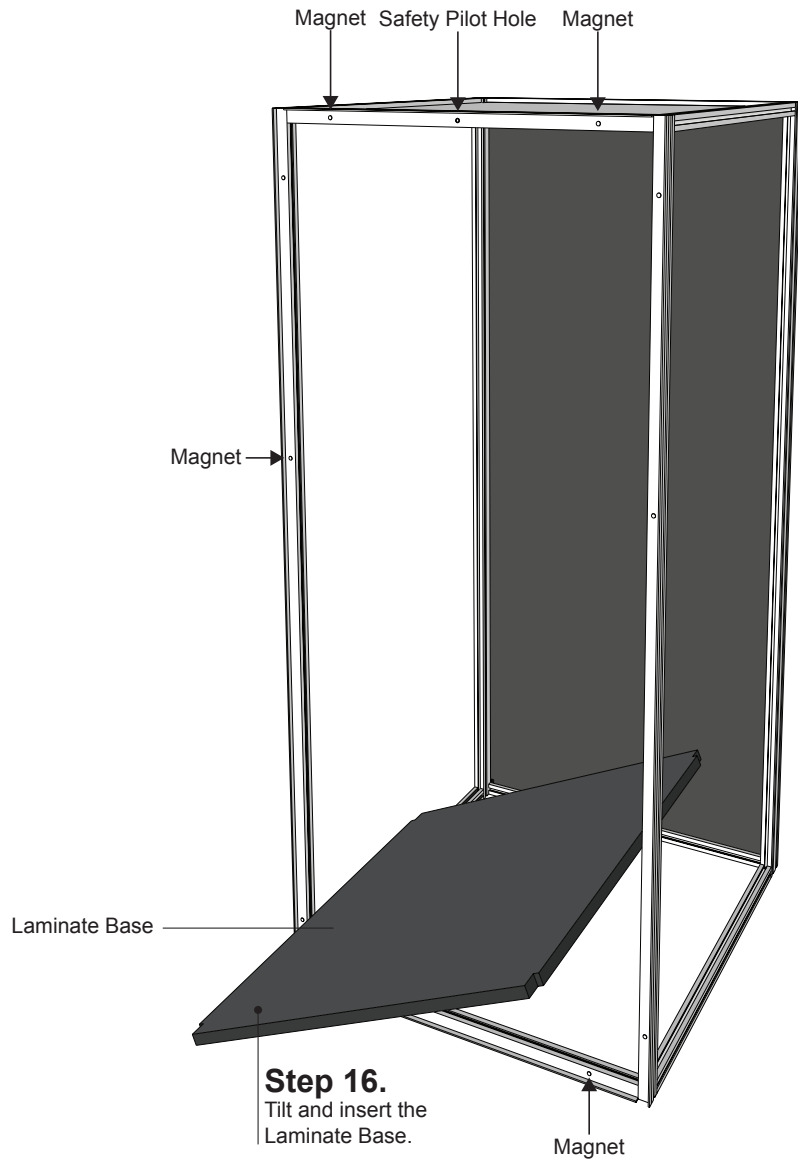

Step 17.
Attach the Plexiglass Front Panel and insert the Safety Screw.

